

N.º DE ELEMENTO	REFERENCIA	DESCRIPCIÓN	CANTIDAD
1	MEDD104	PLACA BASE	1
2	MEDD204	PLACA BASE	1
3	MEDD3	RODILLO	2
4	MEDD4	ARANDELA PLACA BASE	2
5	MEDD504	EJE	1
6	MEDD6	EMBOLO SETA	1
7	MEDD7	GUIA	2
8	9.3X2.4	JUNTA NBR 10x2,5	2
9	MEDD804	MANGO	1
10	MEDD13	ANILLO SEGMENTO	1
11	MEDD9	SOPORTE LATERAL	2
12	MEDD14	TORNILLO ALLEN M10x1,5 8.8	2
13	MEDD10	TORNILLO	2
14	MEDD15	TUERCA M10x1,5 8.8	2
15	MEDD11	TUERCA SETA	1
16	MEDD16	TORNILLO M6x1 12.9	2
17	MEDD12	EMBOLO TETON	1
18	A930208	ENCHUFE HEMBRA	4
19	A930108	ENCHUFE MACHO	4
20	MEDD17	MUELLE 0,9 x 8,5 x17 x 6 espiras	1
21	TMM 18X1.5	TAPON MACHO METRICO	1

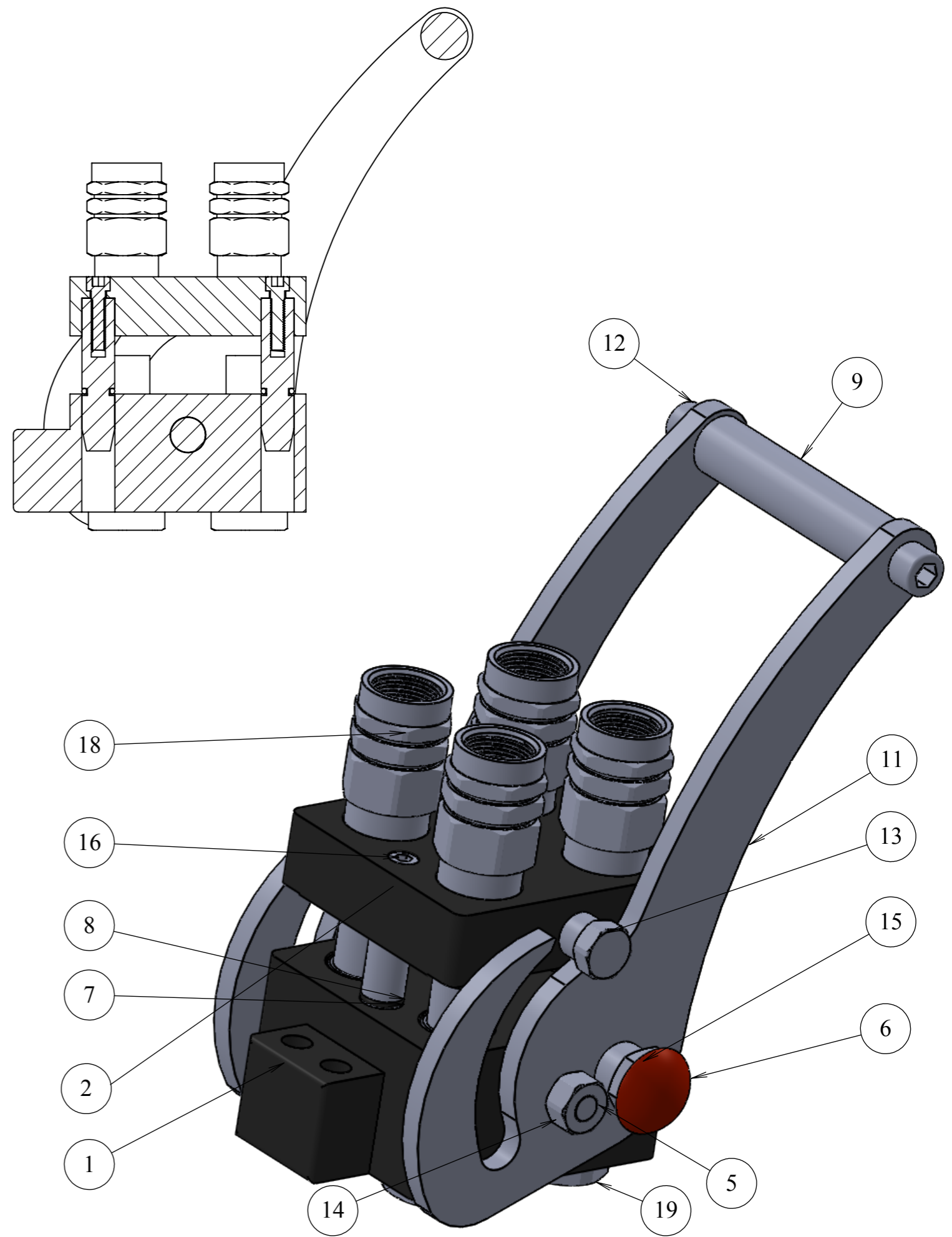

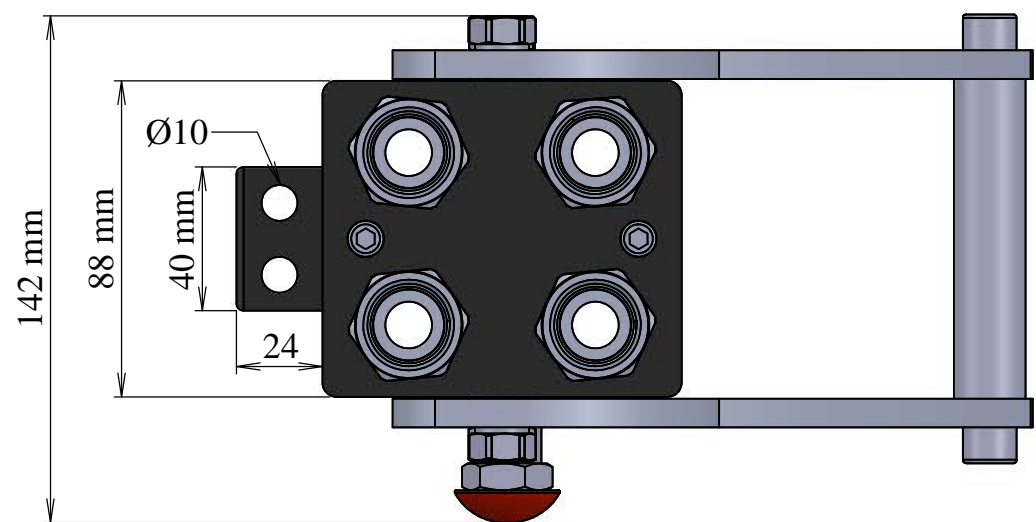
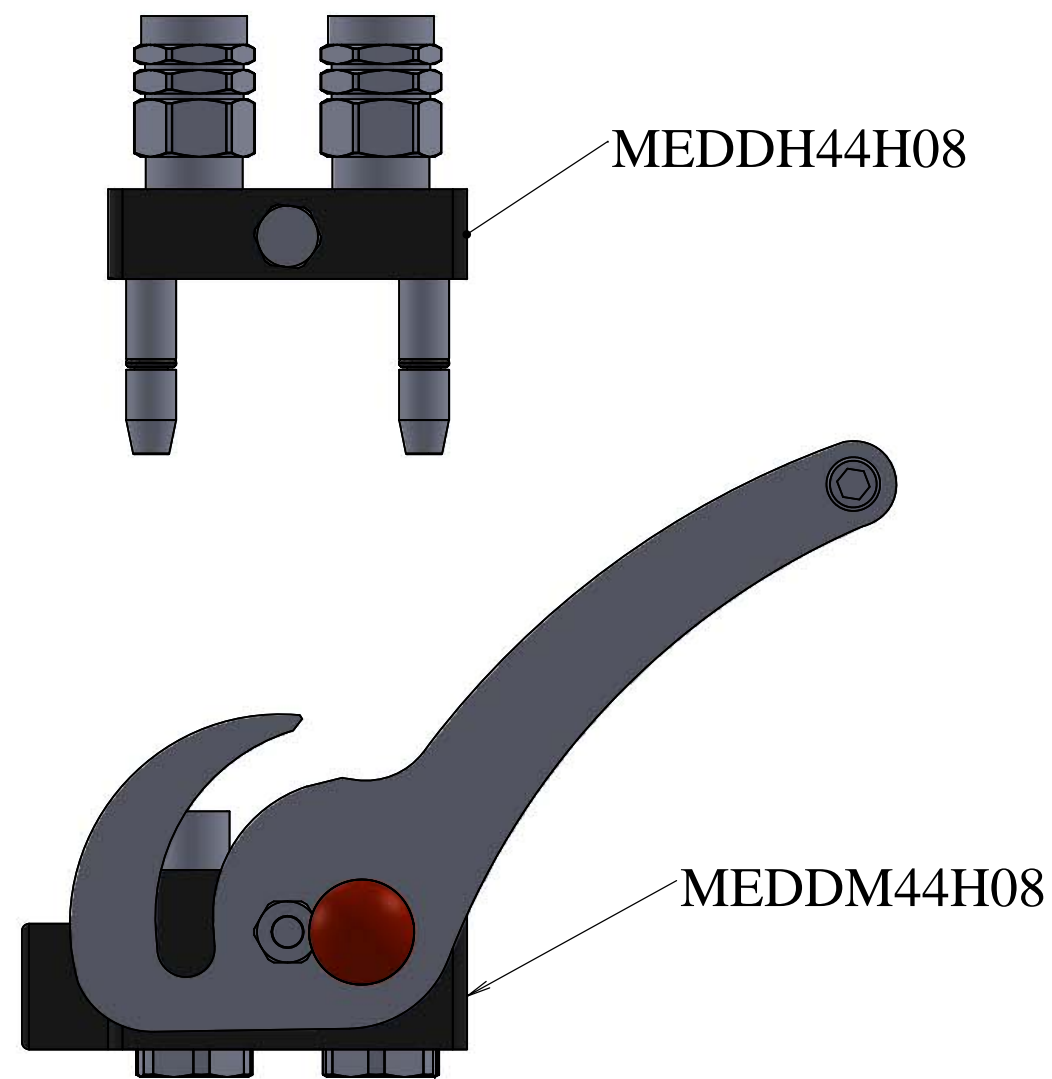
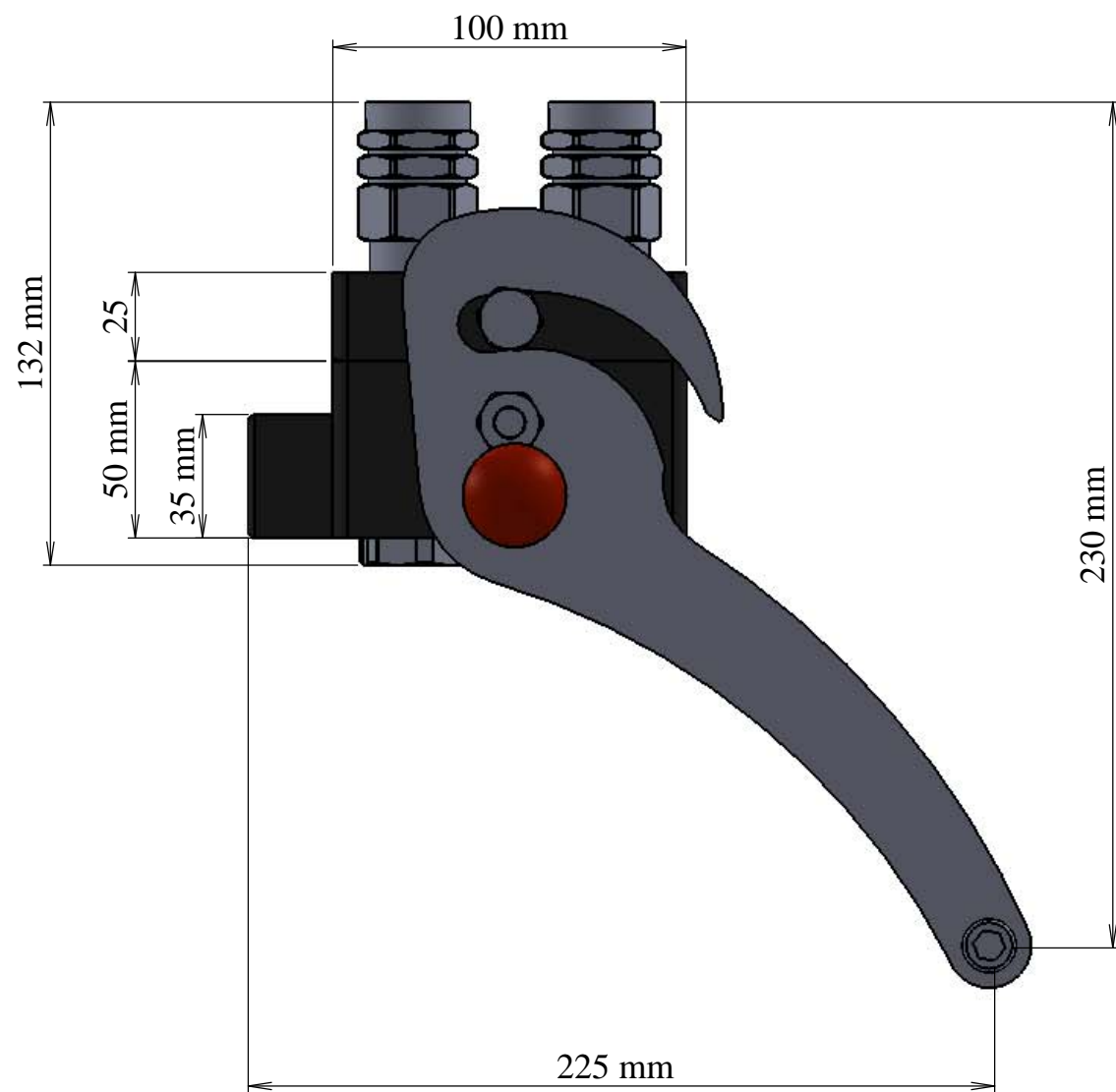

ARTÍCULO	DESCRIPCIÓN	R1	Presión de trabajo (bar)	Tamaño ISO	Tamaño BG	ENCHUFE	CAUDAL MAX (l/min)	HEXAGONAL
A930208	V.PLANA MULTIENCHUFE H 1/2 ROSCA H	1/2" BSP	350	10	2	H	46	30
A930108	V.PLANA MULTIENCHUFE M 1/2 ROSCA H	1/2" BSP	350	10	2	M	46	30