

## Check Valve

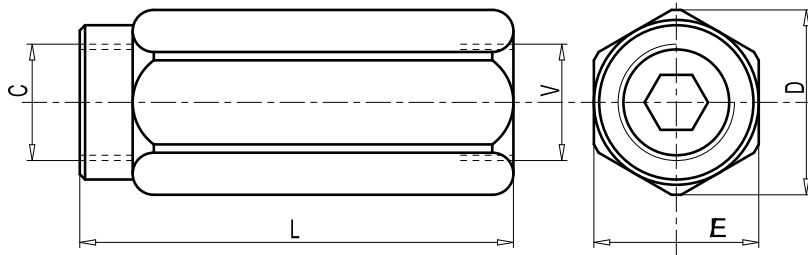

## VU...

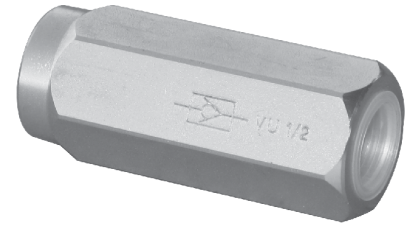

Code Number	Type	Max. Flow	Max. Pressure	L	E	D
		Lt./min	Bar	mm	mm	mm
V0592	VU 1/8	3	350	44	14	16
V0590	VU 1/4	20	350	62	19	21
V0600	VU 3/8	45	350	68	24	26,5
V0610	VU 1/2	70	350	77	30	34
V0620	VU 3/4	110	350	88	36	40

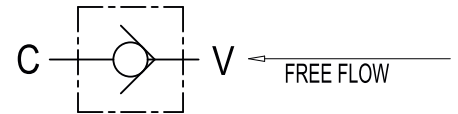

## Crossover Relief Valve

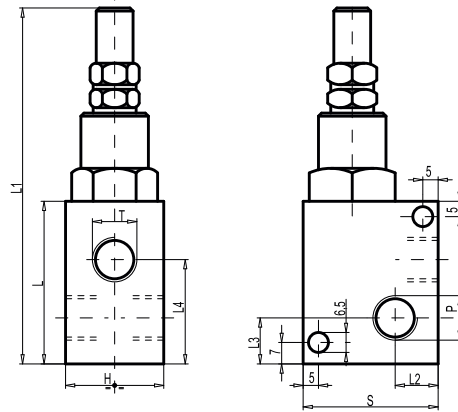

## VMP...

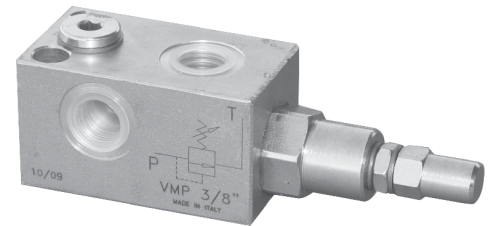

Code Number	Type	Max. Flow	Max. Pressure	L	L1	L2	L3	L4	H	S
		Lt./min	Bar	mm	mm	mm	mm	mm	mm	mm
V0689	VMP 1/4 L	30	350	52	114	12	13	34	30	40
V0690	VMP 3/8 L	40	350	55	117	12	15	35,5	30	40

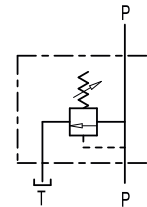

## Differential Type Relief Valve

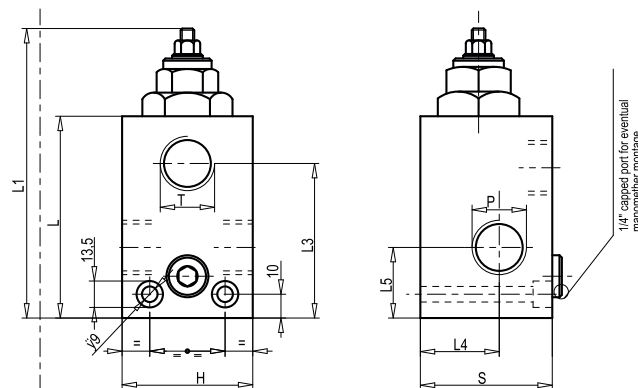

## VMPP...



Code Number	Type	Max. Flow	Max. Pressure	L	L1	L2	L3	L4	L5	H	S
		Lt./min	Bar	mm	mm	mm	mm	mm	mm	mm	mm
V0725	VMPP 3/4	120	350	94	135	32	72	35	32	60	60
V0735	VMPP 1	180	350	94	135	30	69	34	23	60	60

